

机加工滚针轴承

D 10-27mm-NK9/16-TV1)

参数信息:

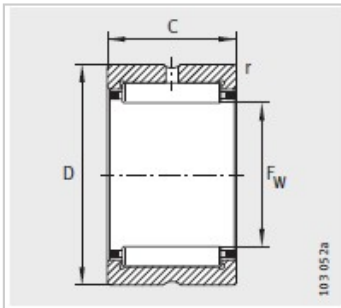
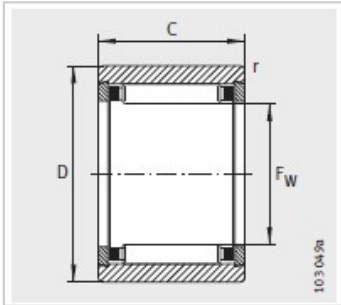

型号1 :	NK9/16-TV1 )
型号2 :	-
型号3 :	-
X-life :	XL
质量m kg :	12.8

尺寸mm :

F :	9
D :	16
C :	16
r min :	0.3
静载荷 :	6600
动载荷 :	7100
疲劳极限载荷/N :	1190
极限转速 :	31000
参考转速 :	32000

: